



hybrid

Quick Installation Guide

Live!

Titanium-20 series

GENEXIS

CONTENTS

1.	Live! overview.....	2
2.	Installation.....	4
3.	Network setup.....	7
4.	Wireless setup.....	8
5.	Configuring your Live!.....	9
6.	Troubleshooting.....	10

1. LIVE! OVERVIEW





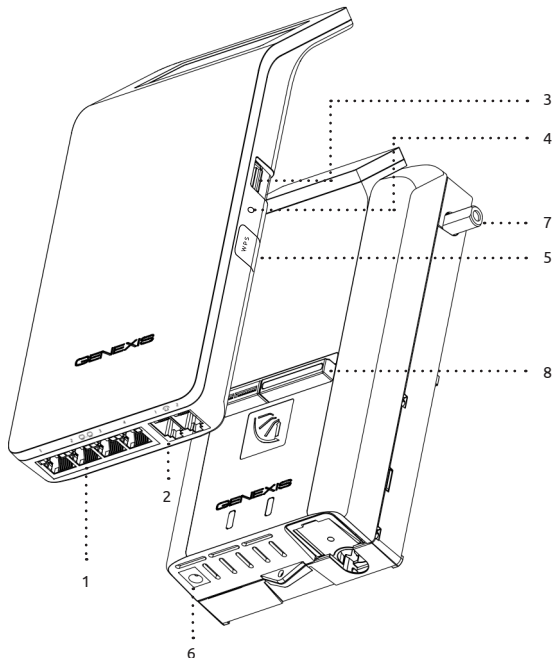

User interfaces

	Description
1	Live! Ethernet LAN ports
2	Live! Telephony ports
3	Live! USB 2.0 port
4	Reset button (recessed hole)
5	WPS button
6	Element power port
7	Universe CATV connector
8	Hybrid Interface connector

Depending on your specific product type, port configuration may differ.



Status feedback LEDs:

	Activity	Description
	On Off	Powered successfully Power not connected
	On Off	Optical link activated No optical link
	On Off	CATV enabled CATV disabled
.....		
	On On (red) Blink (green) Off	Successful data uplink Hardware error Firmware upgrade / provisioning initializing No data uplink
	On Blink Off	Phone line enabled Phone line initializing Phone line disabled
	On Blink Off	Internet connection enabled Internet connection initializing Internet connection disabled
	On Blink Off	WLAN enabled WPS active WLAN disabled
LAN ports	Green Yellow	1000M link - blink on activity 100/10M link - blink on activity

Buttons:

	Function	Action
Reset	Reboot	• Press reset button for less than 5 seconds and release to initiate reset.
	Factory Default	• Press and hold reset button for more than 5 seconds (when LEDs will blink) and release to initiate a factory reset. <i>All configuration data will be lost!</i>
WPS	WPS	• Press WPS button for less than 5 seconds and release to initiate WPS on WLAN.
	Toggle on/off	• Press WPS button for more than 5 seconds (when LEDs will blink) and release to toggle WLAN state on/off.

2. INSTALLATION



Step 1: Installing the Hybrid Live!

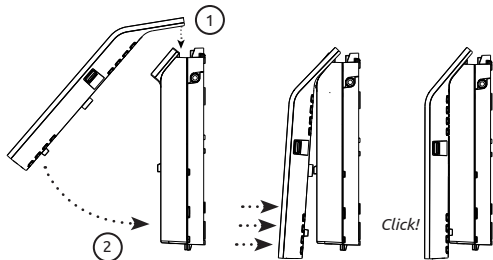

Click the Hybrid Live! module on the Hybrid Element, as shown in the picture.

Note: Proper installation does not require excessive force.



Step 2: Powering the device

Connect the 12V plug of the supplied adapter to the Hybrid Element and connect the adapter to a power socket. The unit will now start up. During the start-up sequence the   LEDs are on, other LEDs may blink.

When the start-up sequence has finished the following LEDs should be on:   .

The complete start-up sequence may take several minutes.

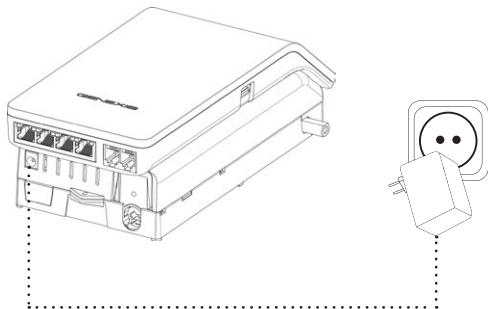

Step 3: Connecting your computer

Connect your computer to one of the Ethernet LAN ports on the Hybrid Live!, using an Ethernet cable with a RJ-45 connector. Your provider can tell you which ports to use.

Note: refer to section "fixed network setup" if your connection is not working directly from the start.

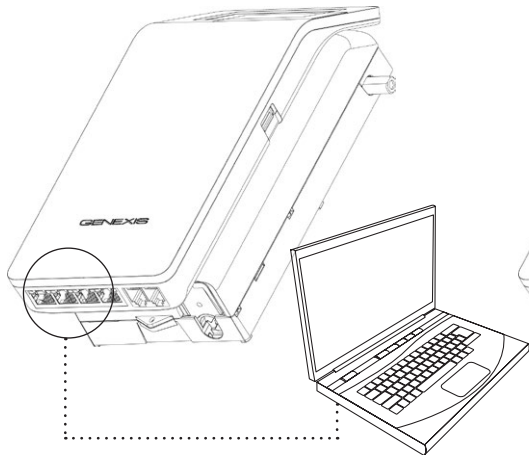

Step 4: Connecting your telephone

This step is only relevant if the Hybrid Live! has voice ports.

A standard analog telephone handset can be connected to the active voice ports, using a RJ-11 cable. The  LED indicates if voice is enabled and operating correctly. Your provider can tell you which ports to use.

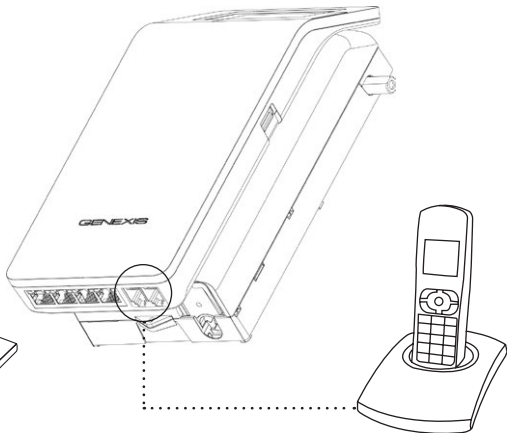

Step 5: Connecting your analog television or radio

This step is only relevant if your Hybrid configuration has a CATV receiver.

Connect your analog television or radio using a coaxial cable with a male F-connector. The  LED indicates if CATV service is enabled.

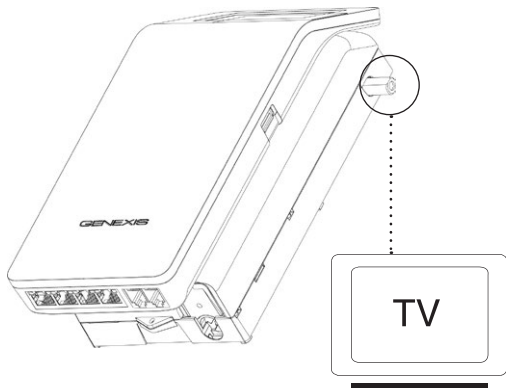

Cleaning instructions:

Your Hybrid product may be cleaned using a soft, dry cloth. For areas of persistent dirt, a damp cloth may be used with mild detergent. Product and LED logos may be damaged by using aggressive cleaning products or ethanol-based cleaners - if in doubt do not clean near these logos. Under no circumstances allow water or cleaning fluid to ingress the product, as this may cause permanent damage and prevent correct operation.

3. NETWORK SETUP

Step 1:

Open the web browser on your computer and check if your connection is working. If your connection is working, you can skip step 2 and 3.

Step 2:

(Instructions for Windows Vista / Windows 7; for other operating systems please contact your service provider)

- On your computer, go to “Start” at the bottom left corner and click on “Control Panel”.
- The Control Panel window will appear. Click on “View Network Status and Tasks” at the “Network and Internet” category.
- The Network and Sharing Centre will appear:
 - For Windows Vista: Click on “Manage network connections” at the top left hand corner.
 - For Windows 7: Click on “Change adapter settings” at the top left hand corner.
- Right click on the correct “Local Area Connection” by identifying the correct network card and click “Properties”.
- Select “Internet Protocol Version 4 (TCP/IPv4)”. Click on “Properties”
- Select “Obtain an IP address automatically”, and “Obtain DNS server address automatically”. Save the settings by clicking “OK”, and close the window by clicking “OK” or “Close”.

Step 3:

Open your web browser and check if your connection is working. If your connection is not working, please refer to the troubleshooting section.

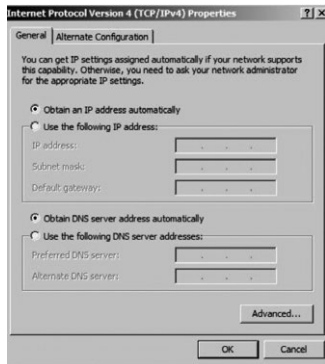

4. WIRELESS SETUP

This section is only relevant if wireless functionality is available on your Hybrid Live!. The  LED indicates if wireless functionality is enabled.

Step 1:

To set up the wireless connection between your computer and the Hybrid Live! you may need the SSID and WPA key of the Hybrid Live!. The SSID is the name of the wireless network. The WPA key is the password needed for your secured wireless network. The default SSID and the WPA key are printed on the label on the rear of your Hybrid Live!.

You may write down these values here:

SSID: _____

WPA key: _____

Step 2:

(Instructions for Windows Vista / Windows 7; for other operating systems please contact your service provider)

- Go to "Start" at the bottom left corner and click on "Control Panel".
- The Control Panel window will appear. Click on "View Network Status and Tasks" at the "Network and Internet" category.
- The Network Connections window will appear. Click on the "Connect to a network".
- Show "Wireless" and select the network (SSID) that is printed on the label.
- If requested press the WPS button on your Hybrid Live!. Alternatively you can connect using the WPA key that is printed on the label.
- Your connection is now operational. Open your web browser and verify that your connection is working. If your connection is not working, please refer to the troubleshooting section.
- After installation you can manually change the SSID and WPA key, by using the web-interface of the Hybrid Live!.

5. CONFIGURING YOUR LIVE!

Note: By default the router is configured properly for most home networks. Changing the configuration is only advised for advanced users and might interrupt your connection. Please refer to page 3 on how to reset the router settings back to the factory default settings.

Step 1:

- Launch the web browser on your computer and enter the router's name 'http://router' or default address 'http://192.168.1.254'. This address is also printed on the label on the back of your Hybrid Live!.

Step 2:

- Log in as 'admin', using the default password 'admin'.











It is strongly advised to change the password after you logged in for the first time.

Step 3:

- Configure the router to the desired configuration. Read the help text for additional information about this setting.

6. TROUBLESHOOTING

Issue	Action
 LED is off	Make sure you have connected the Hybrid Element to a working power outlet, using the adapter shipped along with it. If the LED remains off, please contact your service provider.
 LED is off	There is no valid link on the fiber port. Please contact your service provider.
 LED is off	There is no valid CATV signal on the Universe CATV connector. Please contact your service provider if a CATV signal is expected.
.....	
 Red LED is on	Hardware error. Power down the device, wait for 1 minute, then power the device back on. If the problem persists, contact your service provider.
 LED is off	Voice functionality is not enabled. Please contact your service provider if voice functionality is expected.
 LED keeps blinking	Voice service initialization not completed. Please make sure the phone is not off-hook and the phone line is connected to the correct port. If this issue persists, contact your service provider.

Issue	Action
 LED is off	Internet connectivity is not enabled. Please contact your service provider if routing functionality is expected.
 LED keeps blinking	Internet service initialization not completed. If this persists, contact your service provider.
 LED is off	Please check in the web interface if wireless functionality is enabled. Please contact your service provider if wireless functionality is expected.
Web interface is not reachable	Check if Internet functionality is enabled , and if you have the correct router IP address. If you changed the router IP address, you can perform a "Factory Default reset" to restore the default IP address.
How to reset the router settings?	See page 3

Europe-EU Declaration of Conformity



Hereby, Genexis BV declares that this product is in compliance with the essential requirements and other relevant provisions of Directive 1999/5/EC.

GENEXIS

Copyright © Genexis 2014 rev.2